

1W, Fixed input voltage, isolated & unregulated single output

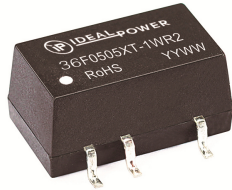

Continuous Short Circuit Protection



**CE** **UL** **US** Patent Protection **RoHS**

## FEATURES

- Continuous short-circuit protection
- Operating temperature range: -40°C to +105°C
- High efficiency up to 80%
- SMD package
- Isolation voltage: 3K VDC
- Low ripple & noise
- International standard pin-out

36F\_XT-1WR2 series are specially designed for applications where an isolated voltage is required in a distributed power supply system. They are suitable for

1. Where the voltage of the input power supply is stable (voltage variation:  $\pm 10\%V_{in}$ );
2. Where isolation between input and output is necessary (isolation voltage  $\leq 3000VDC$ );
3. Where the output voltage regulation is not strictly required;
4. Typical application: preceding-stage interference isolation condition; ground-interference canceled condition; digit circuit condition; Voltage-isolation converting condition; normal low-frequency artificial circuit condition; relay drive circuit condition, etc.

## Selection Guide

Certification	Part No.	Input Voltage (VDC)	Output		Efficiency (%/Min./Typ.) @ Full Load	Max. Capacitive Load ( $\mu F$ )
		Nominal (Range)	Output Voltage (VDC)	Output Current (mA)(Max./Min.)		
UL	36F0303XT-1WR2	3.3 (2.97-3.63)	3.3	303/30	65/69	220
	36F0305XT-1WR2		5	200/20	70/74	
	36F0503XT-1WR2	5 (4.5-5.5)	3.3	303/30	68/72	
	36F0505XT-1WR2		5	200/20	76/80	
	36F0506XT-1WR2		6	167/17	76/80	
	36F0509XT-1WR2		9	111/12	76/80	
	36F0512XT-1WR2		12	84/9	76/80	
	36F0515XT-1WR2		15	67/7	76/80	
	36F0524XT-1WR2		24	42/4	76/80	
	36F1203XT-1WR2	12 (10.8-13.2)	3.3	303/30	68/72	
	36F1205XT-1WR2		5	200/20	76/80	
	36F1209XT-1WR2		9	111/12	76/80	
	36F1212XT-1WR2		12	84/9	76/80	
	36F1215XT-1WR2		15	67/7	76/80	
36F1224XT-1WR2	24		42/4	76/80		
--	36F1515XT-1WR2	15 (13.5-16.5)	15	67/7	76/80	
UL	36F2405XT-1WR2	24 (21.6-26.4)	5	200/20	76/80	
	36F2409XT-1WR2		9	111/12	76/80	
	36F2415XT-1WR2		15	67/7	76/80	
	36F2424XT-1WR2		24	42/4	76/80	

## Input Specifications

Item	Operating Conditions	Min.	Typ.	Max.	Unit
Input Current (full load / no-load)	3.3V input	--	404/25	--/70	mA
	5V input	--	250/20	--/60	
	12V input	--	104/15	--/50	
	15V input	--	82/10	--/35	
	24V input	--	52/7	--/30	

Reflected Ripple Current		--	15	--	mA
Surge Voltage (1sec. max.)	3.3V input	-0.7	--	5	VDC
	5V input	-0.7	--	9	
	12V input	-0.7	--	18	
	15V input	-0.7	--	21	
	24V input	-0.7	--	30	
Input Filter		Filter capacitor			
Hot Plug		Unavailable			

### Output Specifications

Item	Operating Conditions		Min.	Typ.	Max.	Unit
Output Voltage Accuracy			See tolerance envelope curve(Fig. 1)			
Line Regulation	Input voltage change: $\pm 1\%$	3.3VDC output	--	--	$\pm 1.5$	--
		Other outputs	--	--	$\pm 1.2$	
Load Regulation	10%-100% load	3.3VDC output	--	18	--	%
		5VDC output	--	12	--	
		6VDC output	--	10	--	
		9VDC output	--	8	--	
		12VDC output	--	7	--	
		15VDC output	--	6	--	
		24VDC output	--	5	--	
Ripple & Noise*	20MHz bandwidth		--	60	150	mVp-p
Temperature Coefficient	Full load		--	--	$\pm 0.03$	%/°C
Short Circuit Protection*	36F24xxXT-1WR2/36F0524XT-1WR2		--	--	1	s
	Others		Continuous, self-recovery			

Note: \* Ripple and noise are measured by "parallel cable" method, please see DC-DC Converter Application Notes for specific operation;  
\*\* Supply voltage must be discontinued at the end of short circuit duration for 36F24xxXT-1WR2 series, and 36F0524XT-1WR2 model.

### General Specifications

Item	Operating Conditions	Min.	Typ.	Max.	Unit
Isolation Voltage	Input-output, with the test time of 1 minute and the leak current lower than 1mA	3000	--	--	VDC
Isolation Resistance	Input-output, isolation voltage 500VDC	1000	--	--	MΩ
Isolation Capacitance	Input-output, 100KHz/0.1V	--	20	--	pF
Operating Temperature	Derating when operating temperature up to 100°C, (see Fig. 2)	-40	--	105	°C
Storage Temperature		-55	--	125	
Casing Temperature Rise	Ta=25°C, nominal input, full load output	--	25	--	
Pin Welding Resistance Temperature	Welding spot is 1.5mm away from the casing, 10 seconds	--	--	300	
Storage Humidity	Non-condensing	--	--	95	%RH
Reflow Soldering Temperature		Peak temp. $\leq 245^\circ\text{C}$ , maximum duration time $\leq 60\text{s}$ at $217^\circ\text{C}$ . For actual application, please refer to IPC/JEDEC J-STD-020D.1.			
Switching Frequency	Full load, nominal input voltage	--	100	--	KHz
MTBF	MIL-HDFK-217F@25°C	3500	--	--	K hours

### Physical Specifications

Casing Material	Epoxy resin (UL94-V0)
Dimensions	12.70*11.20*7.25 mm
Weight	1.6g(Typ.)
Cooling Method	Free convection

**EMC Specifications**

EMI	CE	CISPR22/EN55022	CLASS B (see Fig. 4 for recommended circuit)
	RE	CISPR22/EN55022	CLASS B (see Fig. 4 for recommended circuit)
EMS	ESD	IEC/EN61000-4-2	Contact ±8KV perf. Criteria B

**Product Characteristic Curve**

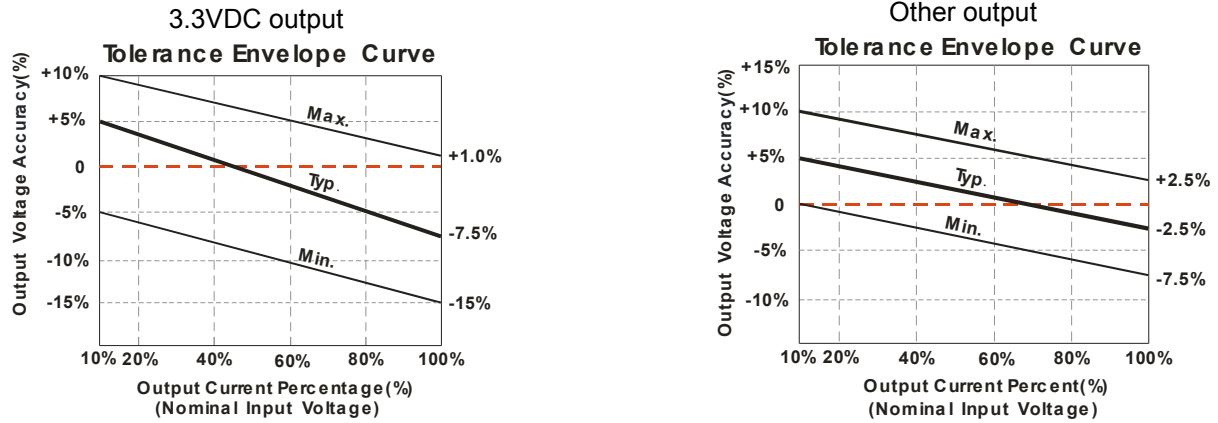

Fig. 1

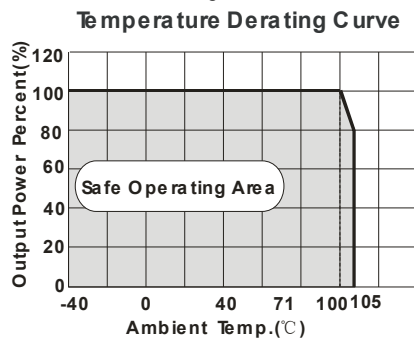
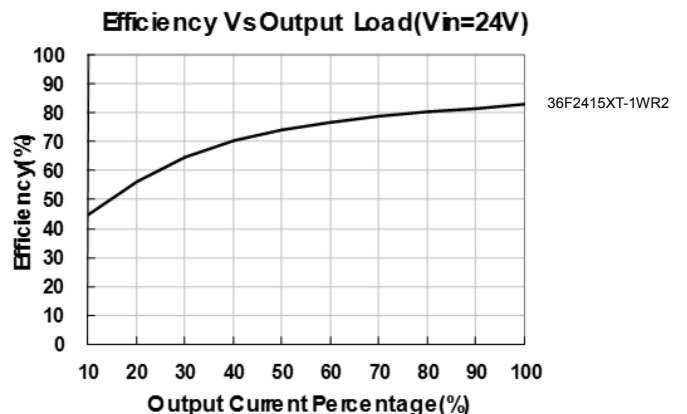
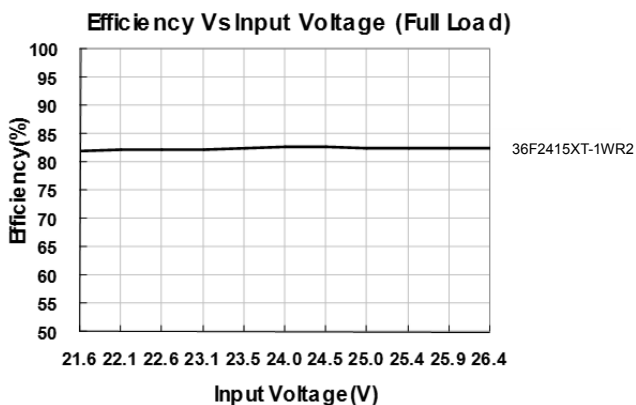
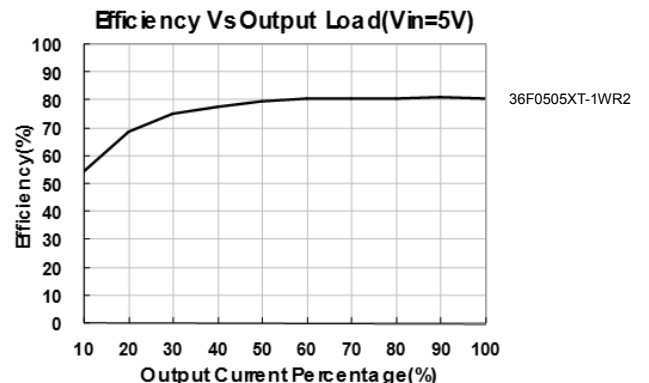
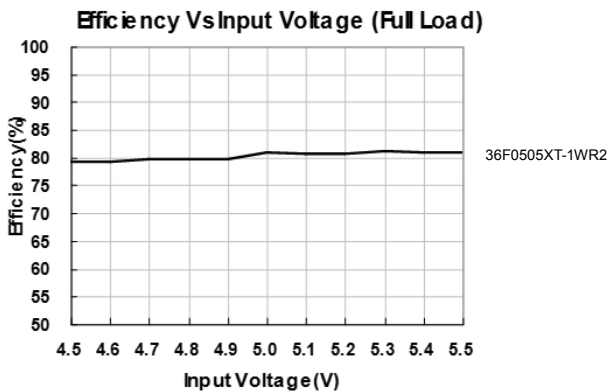

Fig. 2



## Design Reference

### 1. Typical application circuit

If it is required to further reduce input and output ripple, a filter capacitor may be connected to the input and output terminals, see Fig.3.

Moreover, choosing a suitable filter capacitor is very important, start-up problems may be caused if the capacitance is too large. Under the condition of safe and reliable operation, the recommended capacitive load values are shown in Table 1.

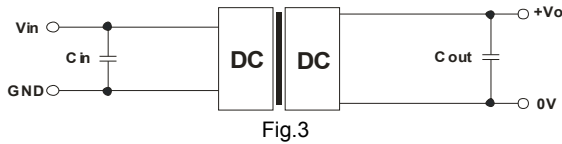

Fig.3

Recommended capacitive load value table (Table 1)

Vin(VDC)	Cin(μF)	Vo (VDC)	Cout(μF)
3.3	4.7	3.3	10
5	4.7	5/6	10
12	2.2	9	4.7
15	2.2	12	2.2
24	1	15	1
--	--	24	0.47

### 2. EMC solution-recommended circuit

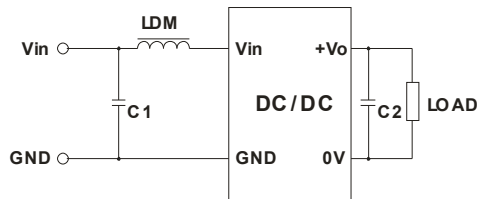

Fig. 4

Input voltage (VDC)		3.3/5/12/15/24
EMI	C1	4.7μF /50V
	C2	Refer to the Cout in Fig.3
	LDM	6.8μH

### 3. Output load requirements

When using, the minimum load of the module output should not be less than 10% of the nominal load. In order to meet the performance parameters of this datasheet, please connect a 10% dummy load in parallel at the output end, the dummy load is generally a resistor, Please note that the resistor needs to be used in derating.

4. For more information please find DC-DC converter application notes on [www.idealpower.co.uk](http://www.idealpower.co.uk)

## Dimensions and Recommended Layout

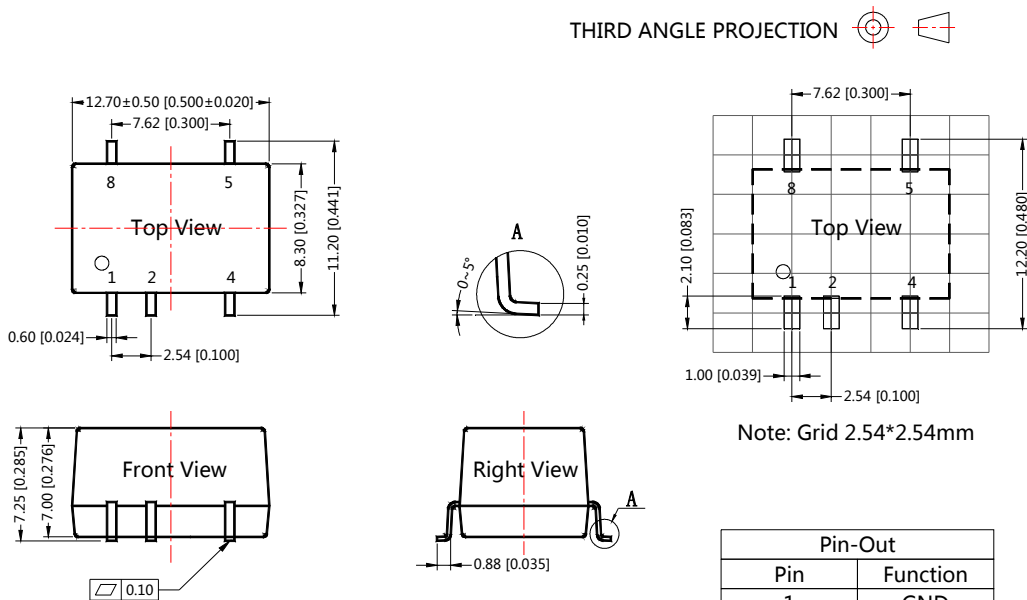

Pin-Out	
Pin	Function
1	GND
2	Vin
4	0V
5	+Vo
8	NC

NC: No Connection

Note:  
Unit: mm[inch]  
Pin section tolerances: ±0.10[±0.004]  
General tolerances: ±0.25[±0.010]

**Notes:**

1. If the product is not operated within the required load range, the product performance cannot be guaranteed to comply with all parameters in the datasheet;
2. The maximum capacitive load offered were tested at nominal input voltage and full load;
3. Unless otherwise specified, parameters in this datasheet were measured under the conditions of  $T_a=25^{\circ}\text{C}$ , humidity<75% with nominal input voltage and rated output load;
4. All index testing methods in this datasheet are based on our Company's corporate standards;
5. The performance parameters of the product models listed in this manual are as above, but some parameters of non-standard model products may exceed the requirements mentioned above. Please contact our technicians directly for specific information;
6. We can provide product customization service;
7. Specifications are subject to change without prior notice.